

TIMBER JOINTS

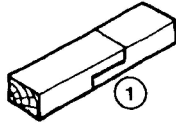

Halving, longitudinal

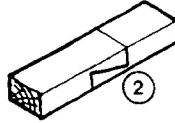

Halving, bevelled

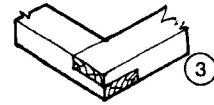

Angle halving

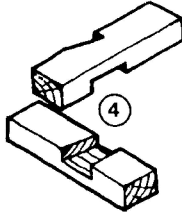

Dovetailed cross-halving

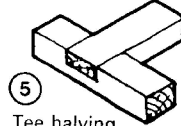

Tee halving

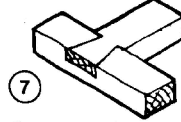

Dovetailed halving

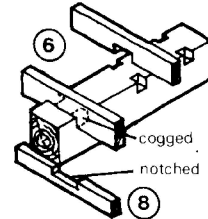

Notching and cogging

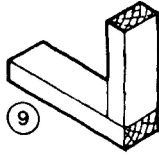

Butt jointed

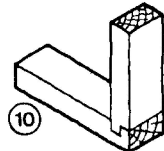

Tongued joint
(see also Nos. 13 and 15)

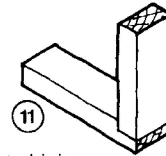

Rebated joint

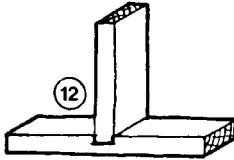

Housed

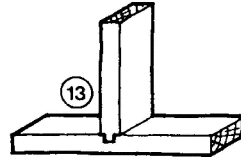

Tongued and grooved

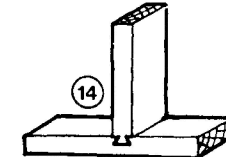

Dovetailed trenched

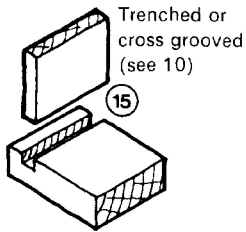

Trenched or cross grooved
(see 10)

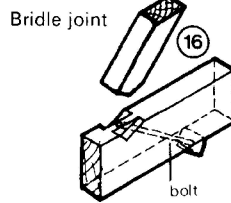

Bridle joint

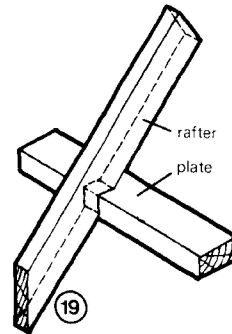

Birdsmouth



Dovetail, angle

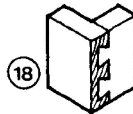

Dovetail, lapped, (stop)

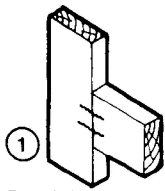

1 Butt joint with corrugated fastener

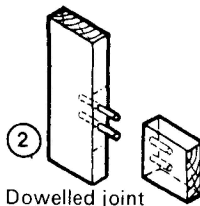

2 Dowelled joint

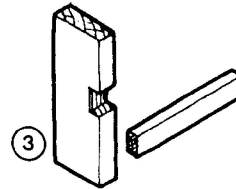

3 Checked (full)

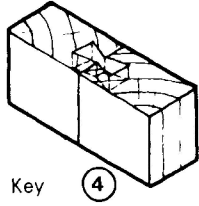

4 Key

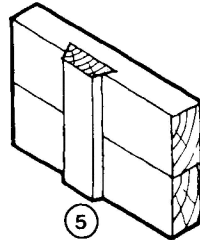

5 Keyed joint

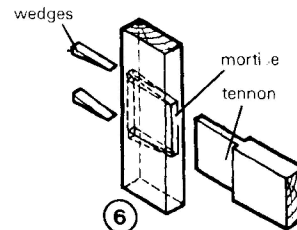

6 Mortise and tenon
wedges
mortise
tenon

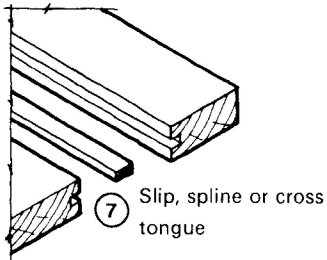

7 Slip, spline or cross tongue

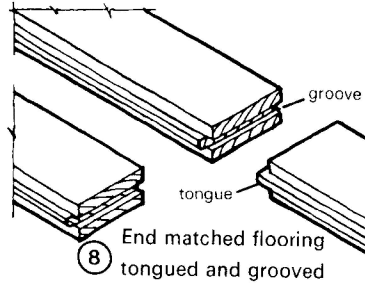

8 End matched flooring
tongued and grooved
groove
tongue

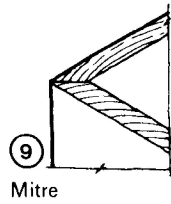

9 Mitre

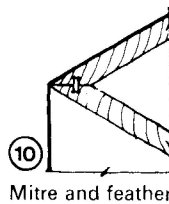

10 Mitre and feather

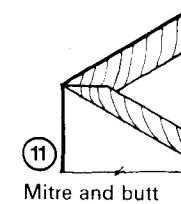

11 Mitre and butt

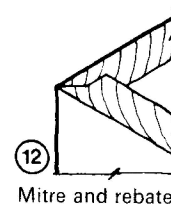

12 Mitre and rebate

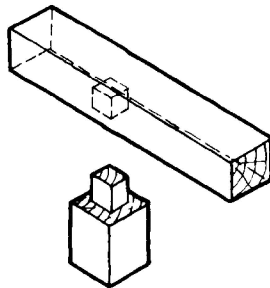

14 Stump tenon (stub)

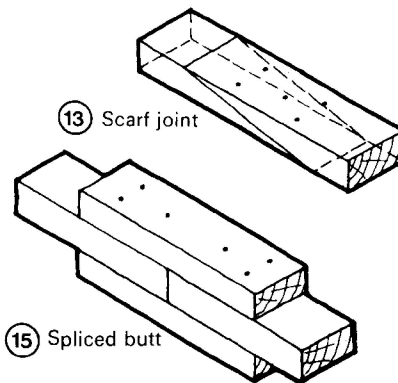

15 Spliced butt
13 Scarf joint